

1089

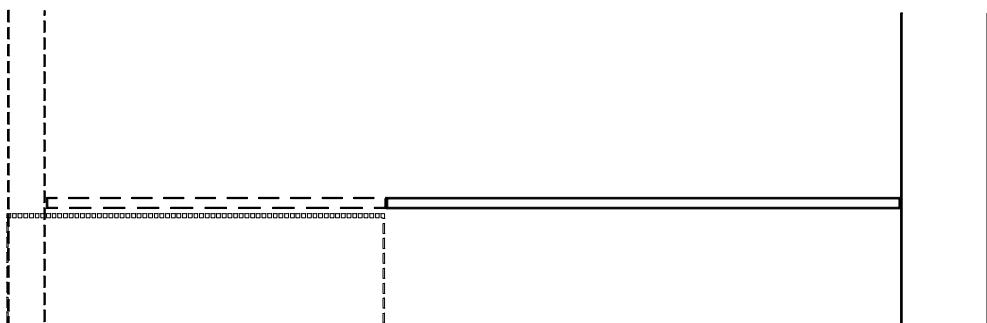

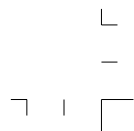

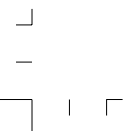

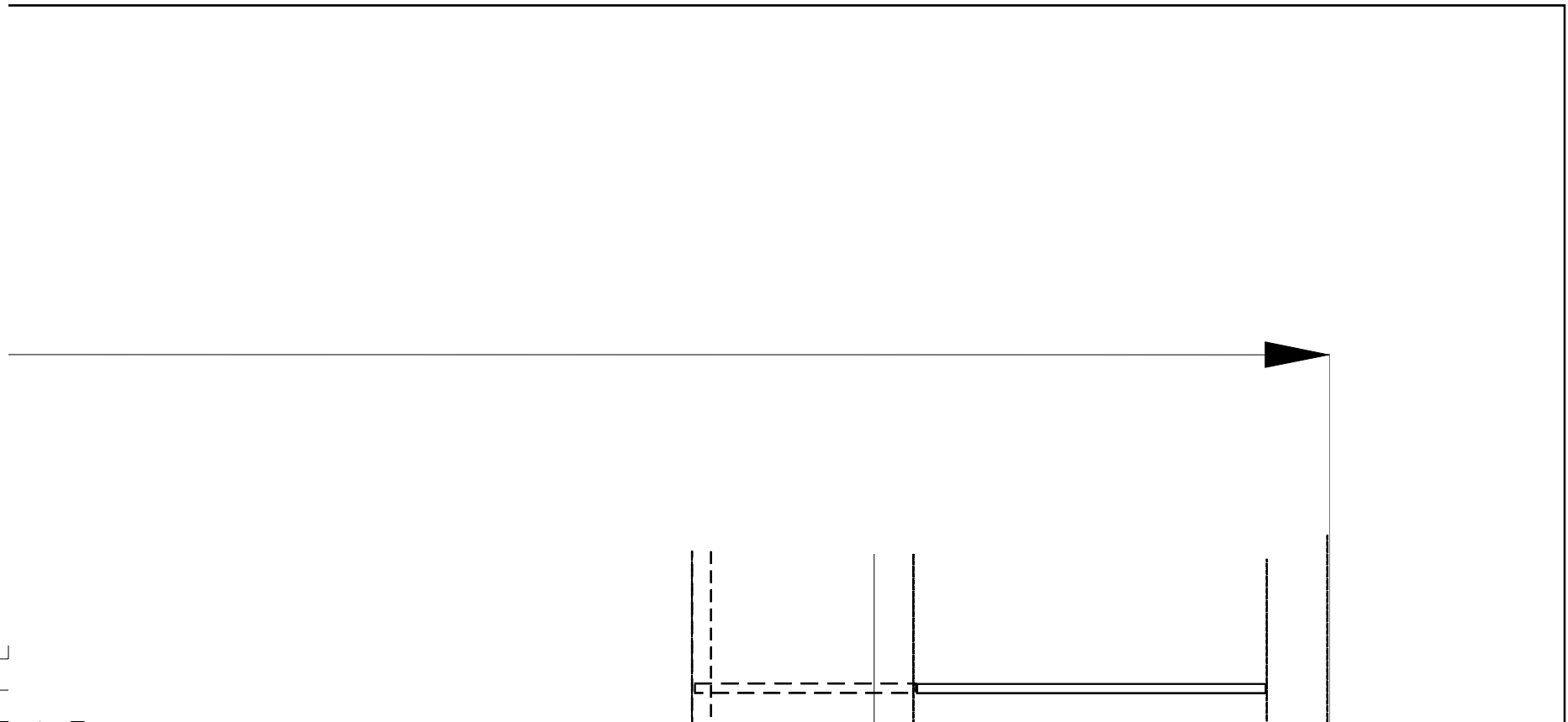
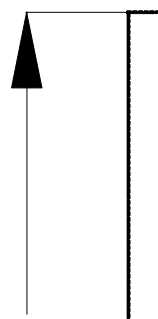

110

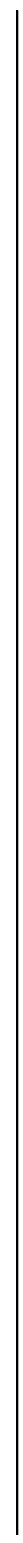

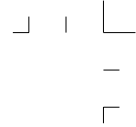
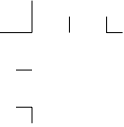

)



55 22

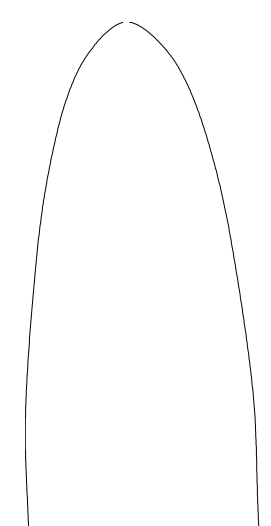
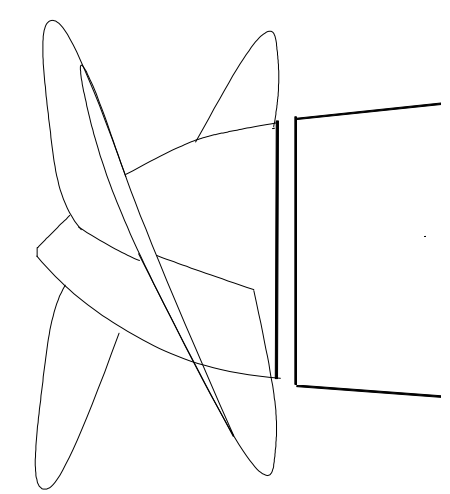
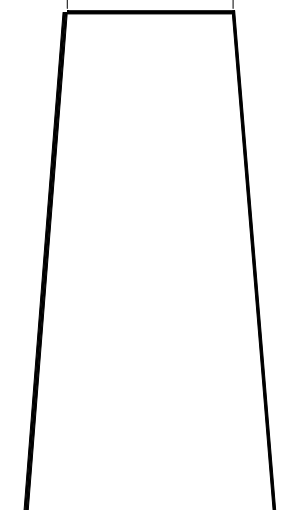
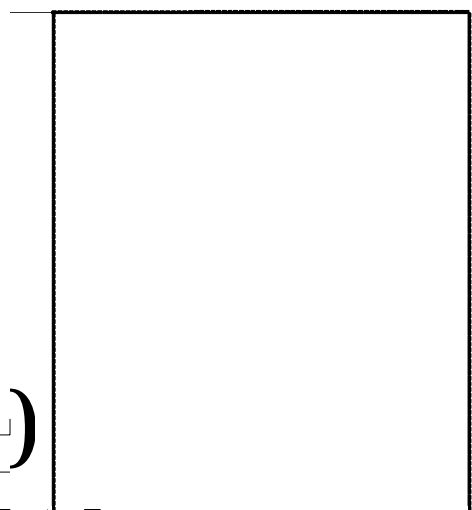

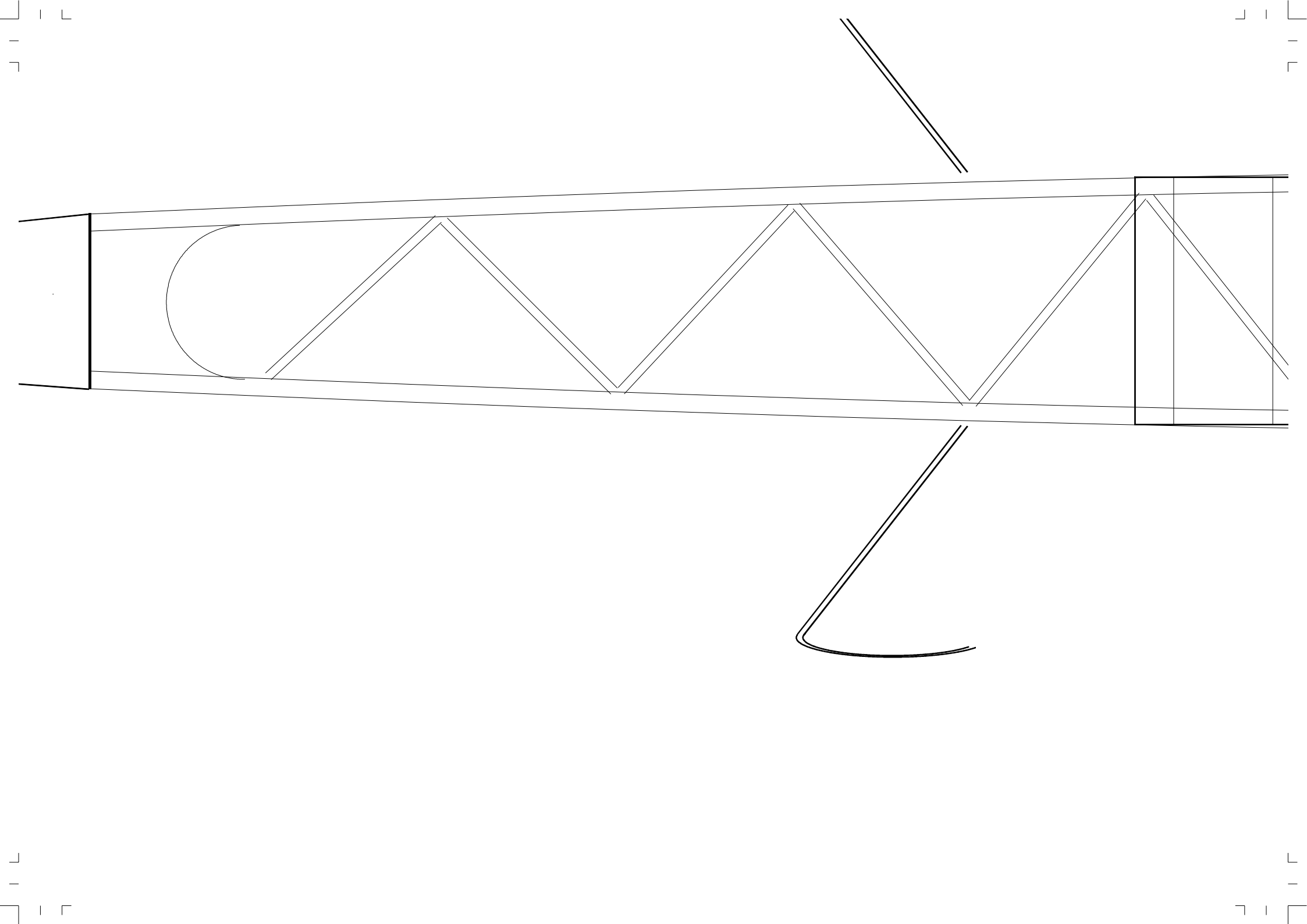

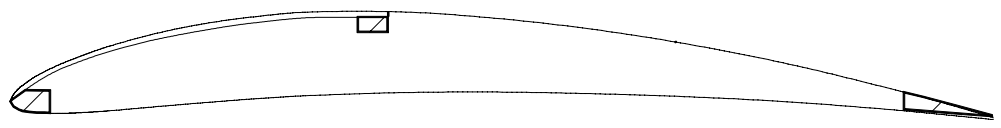
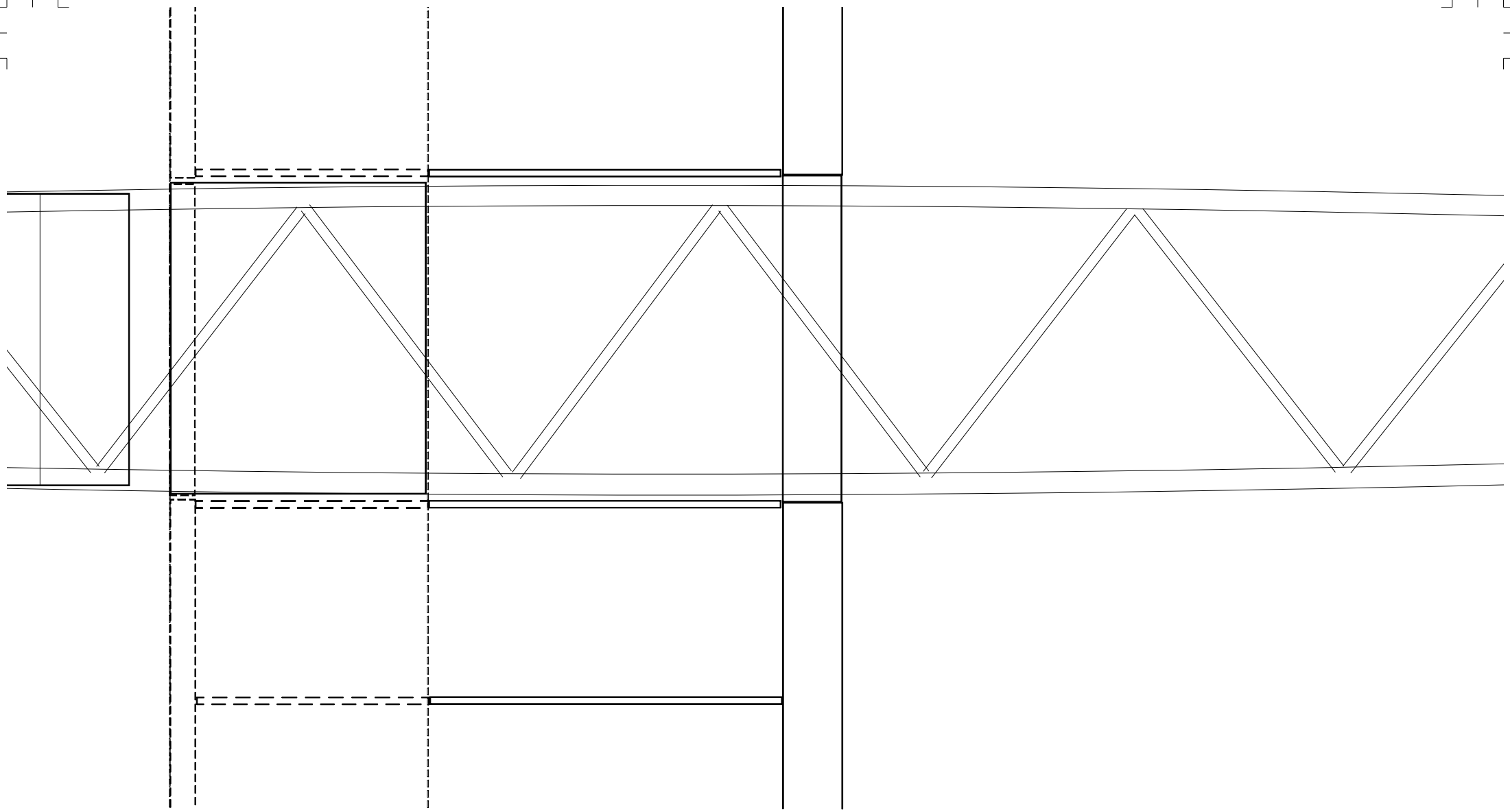

Vingeprofil NACA

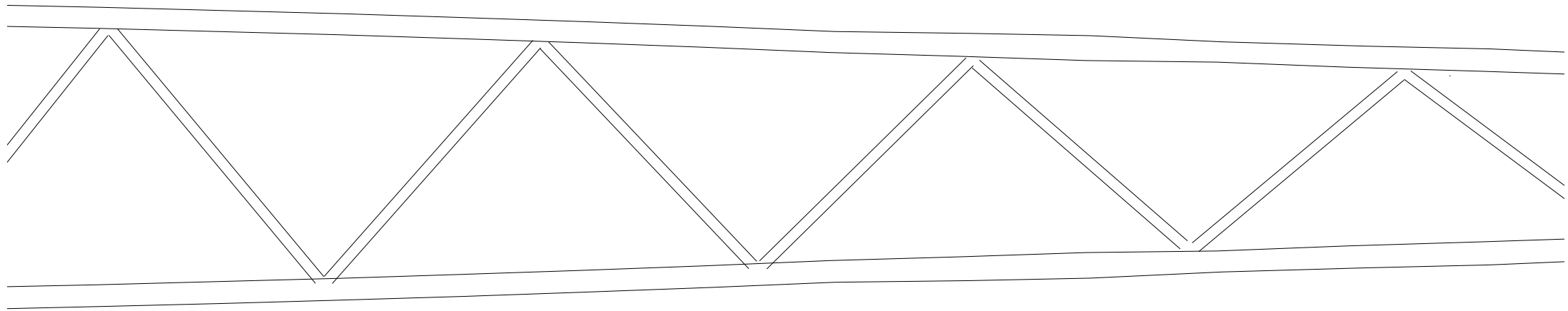

CA 6409

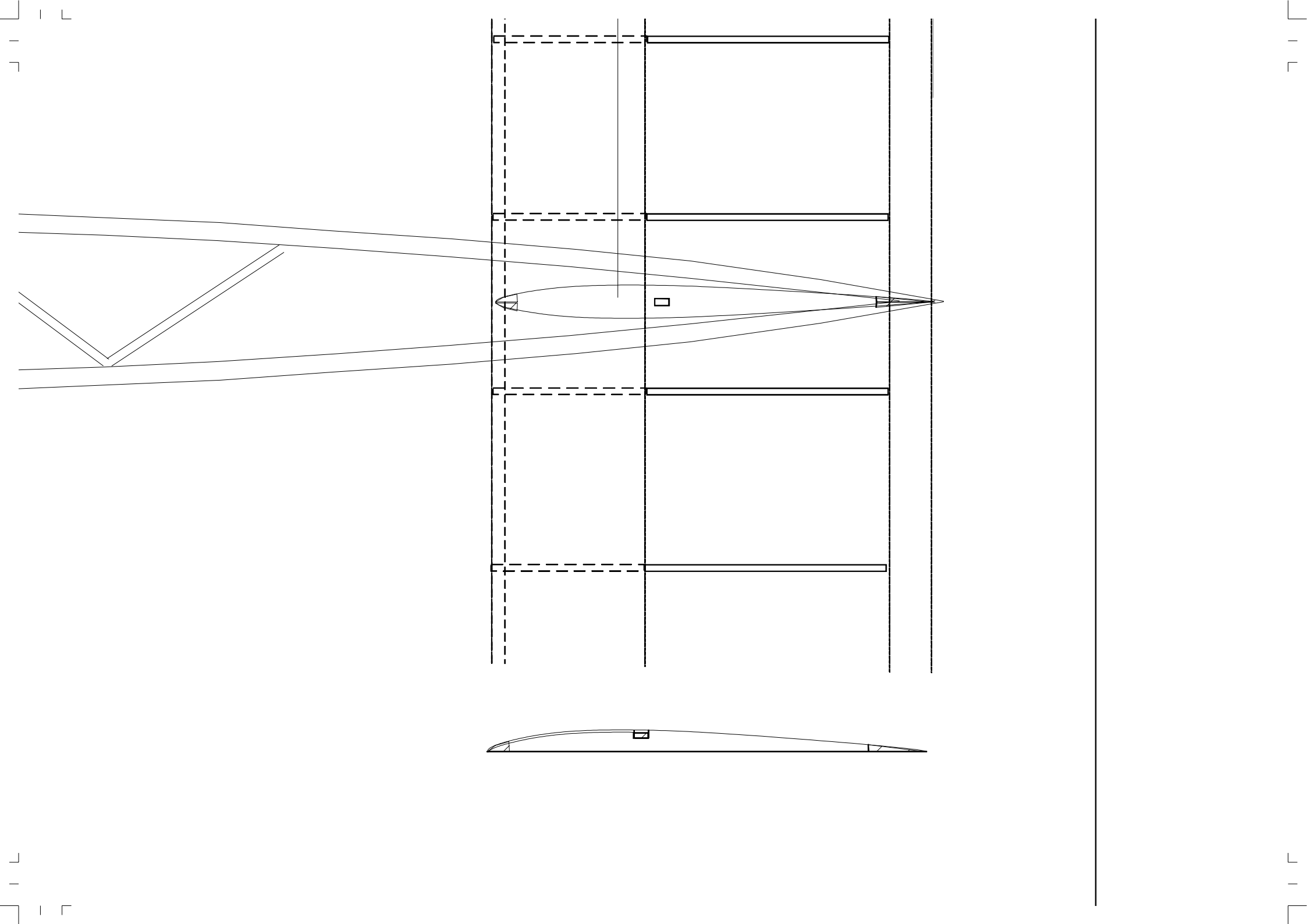

110



130



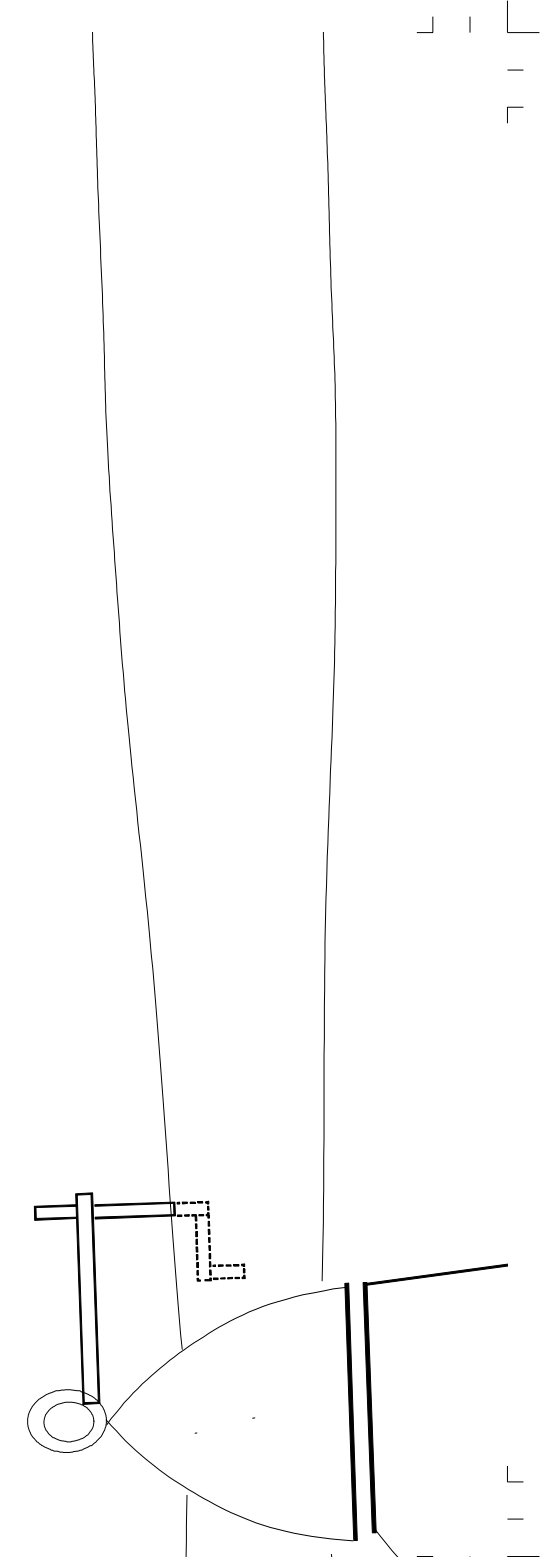
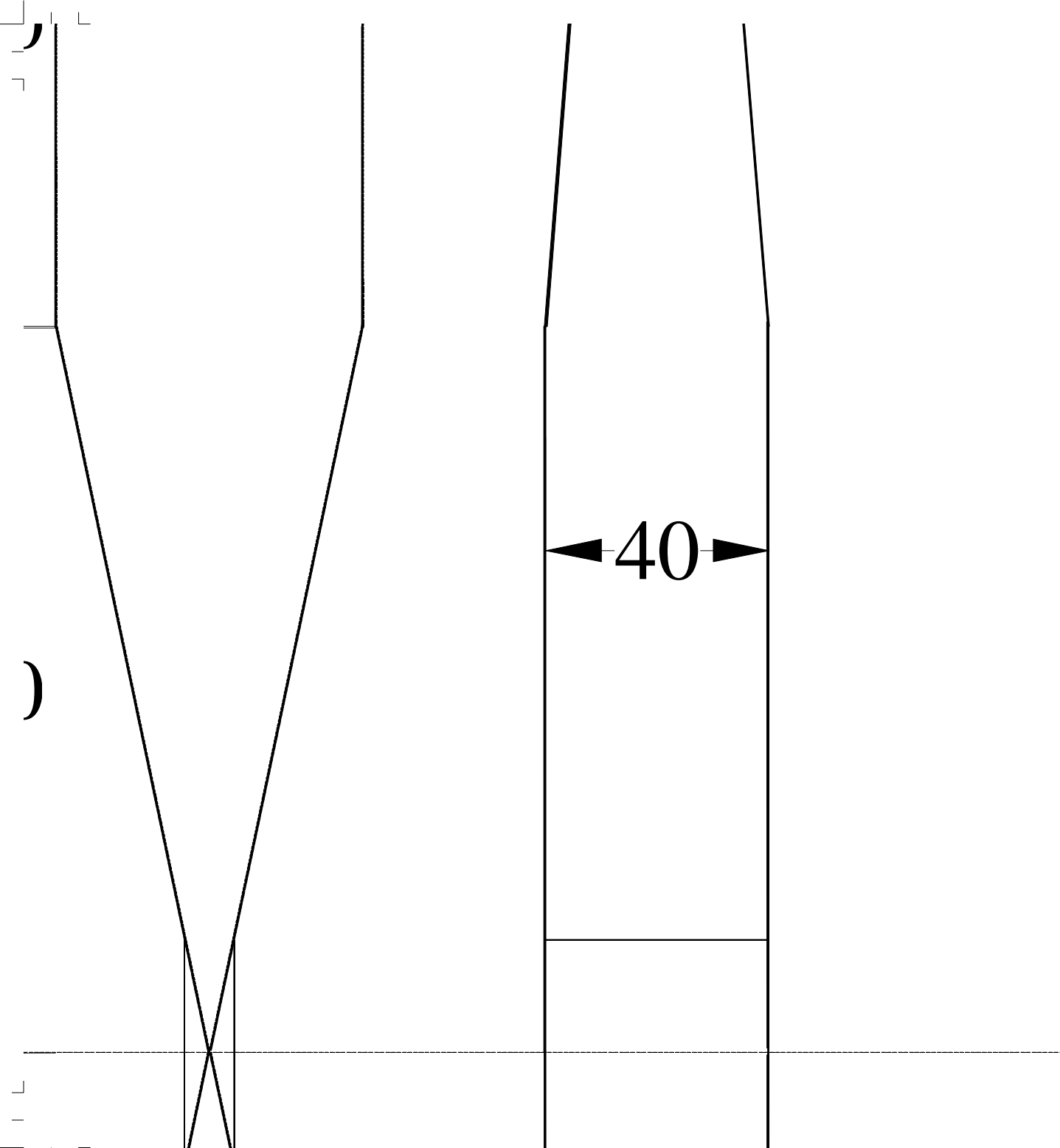

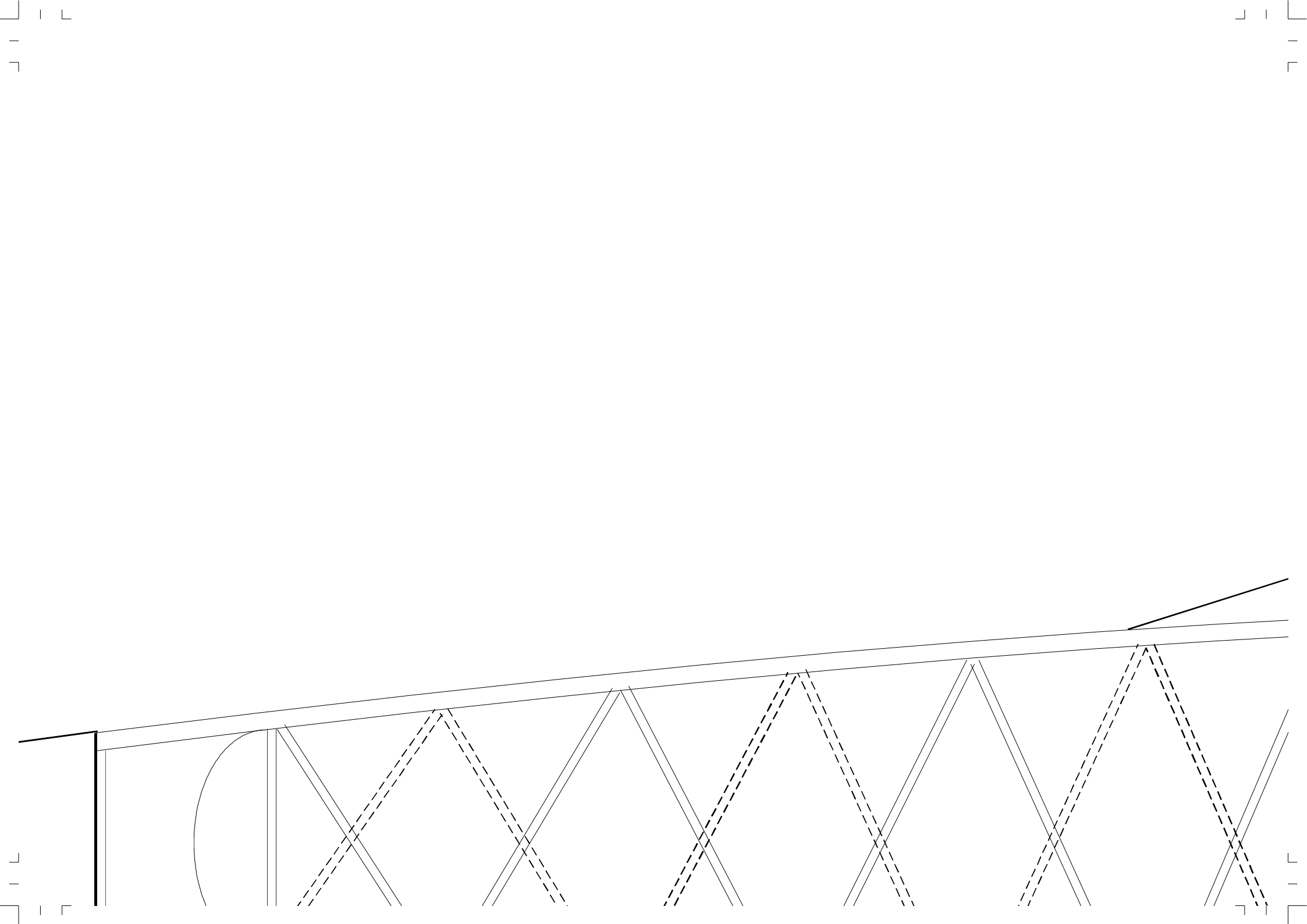

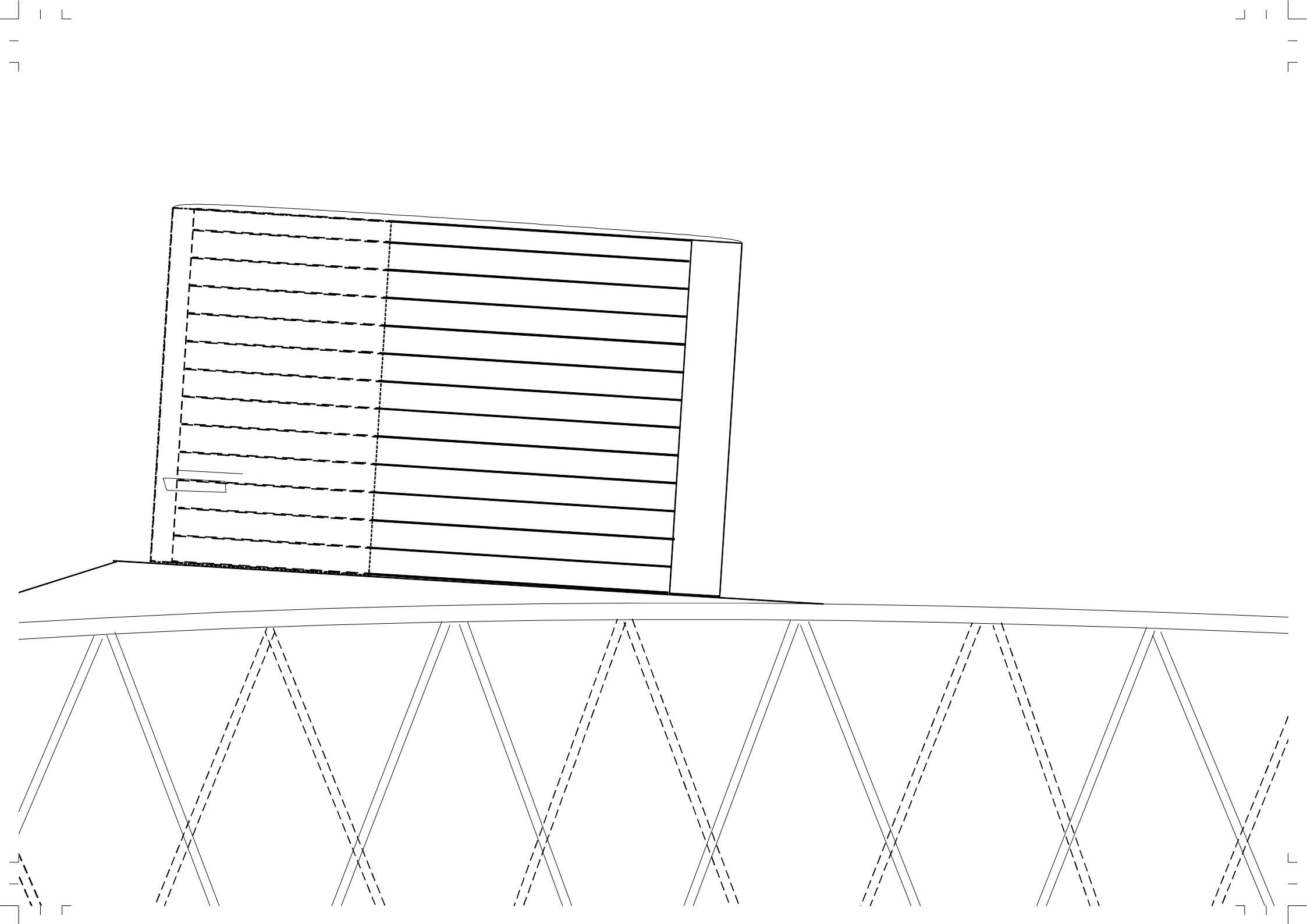

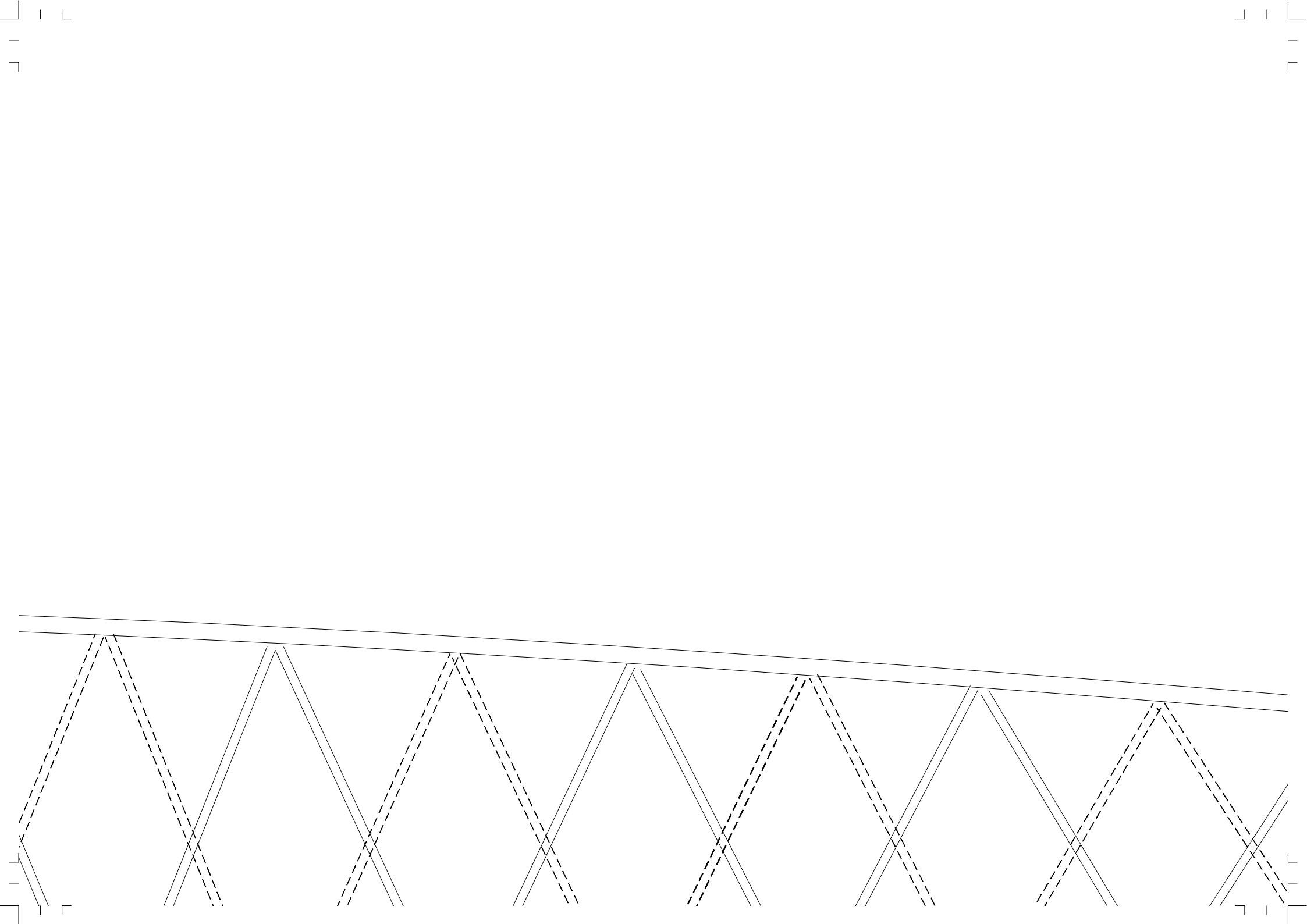

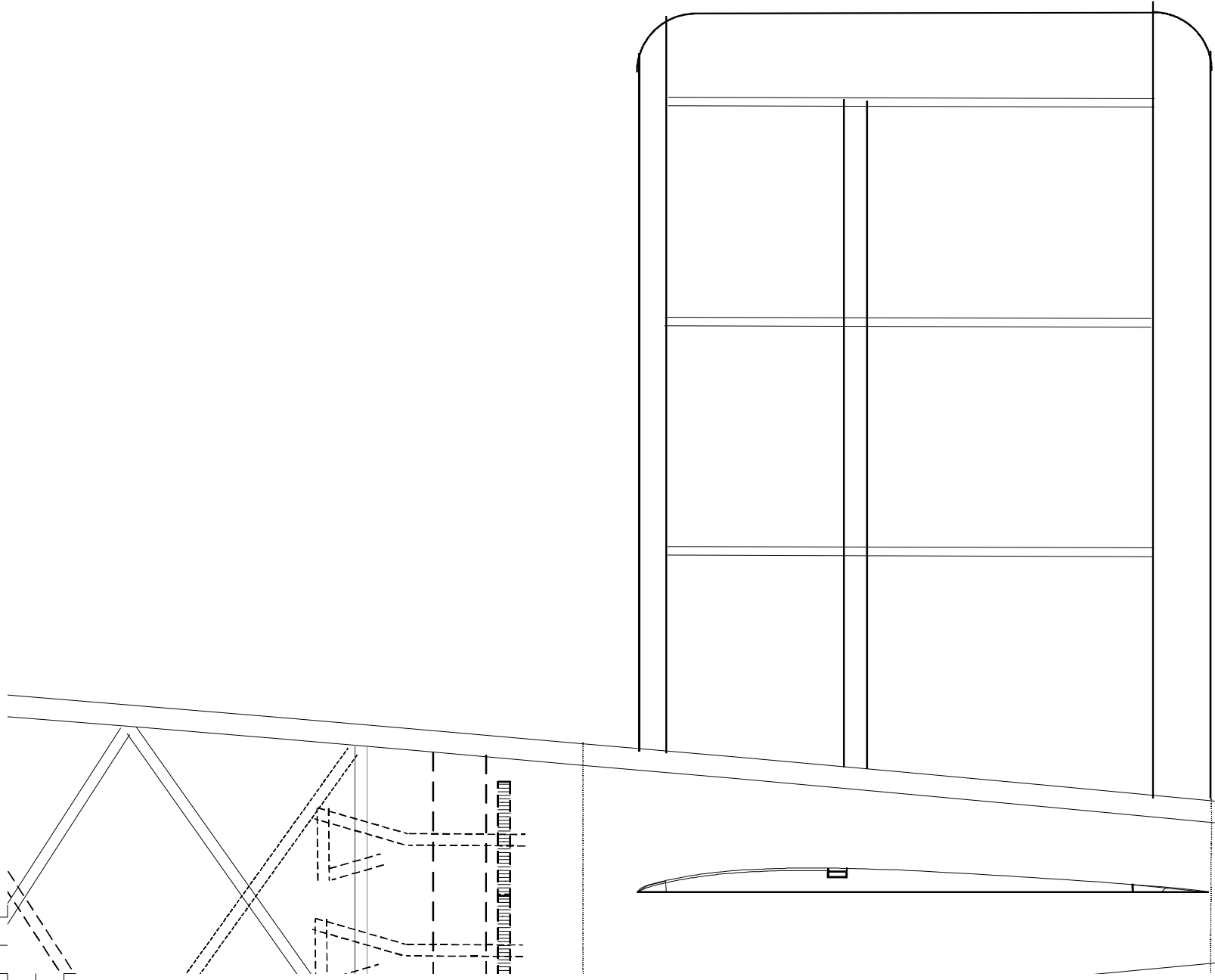

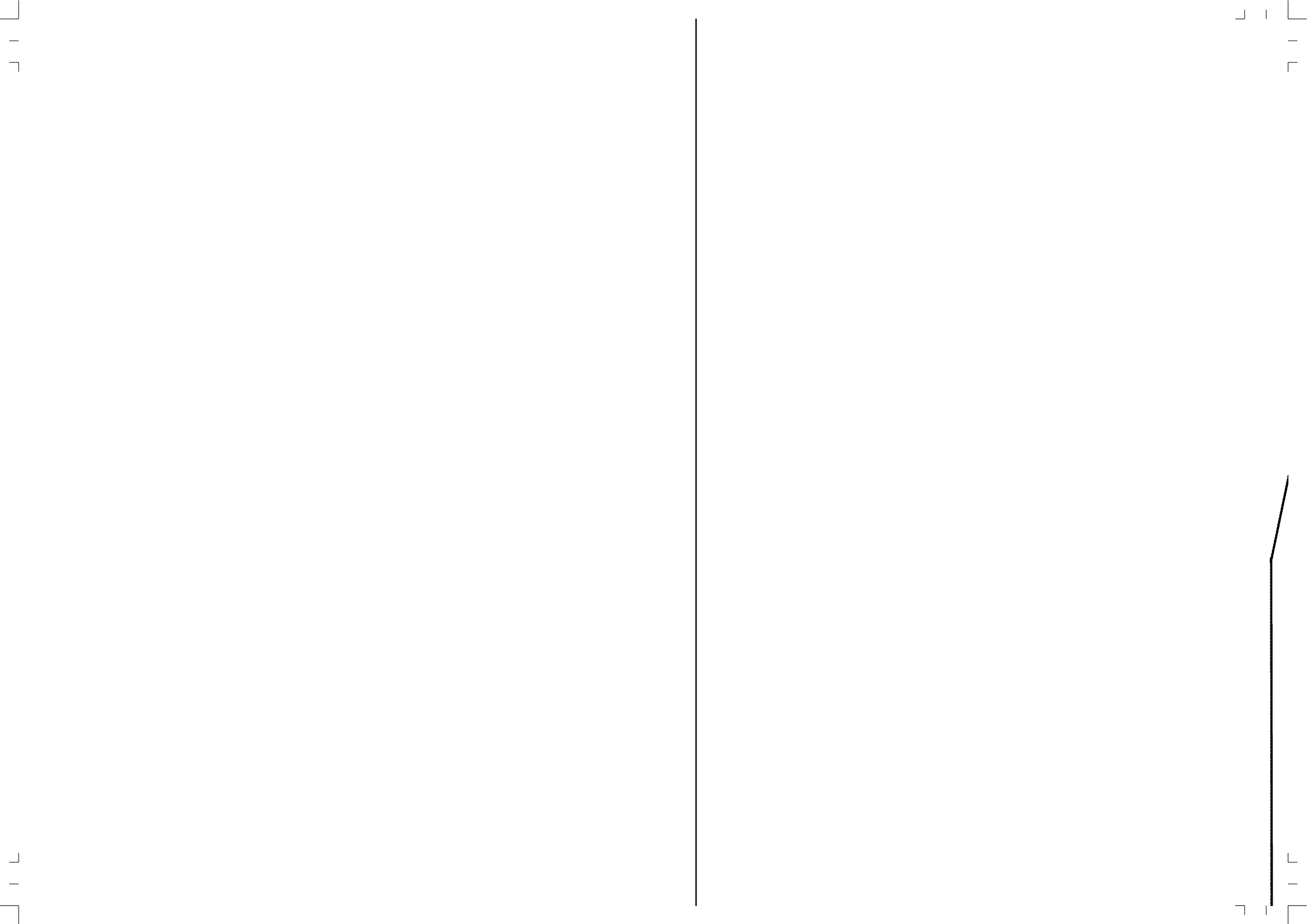

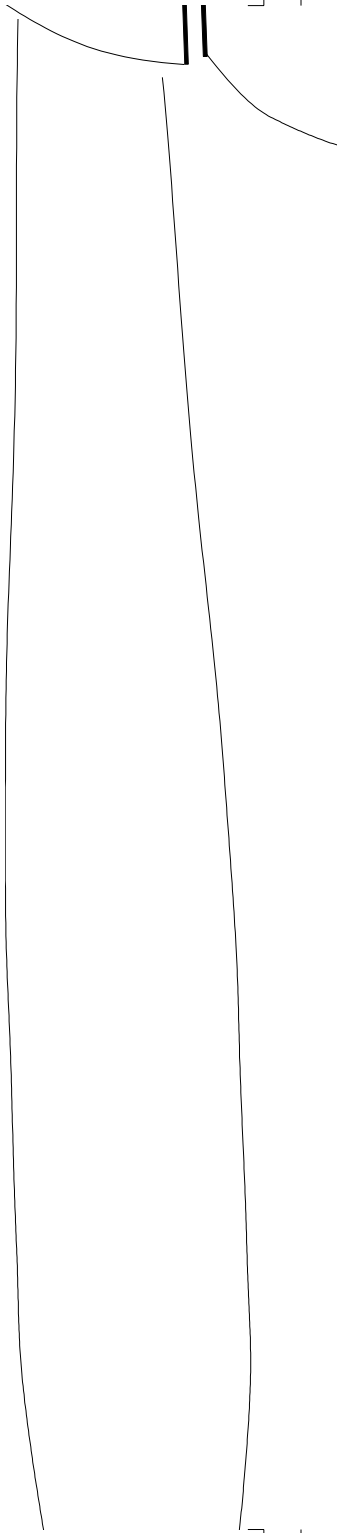
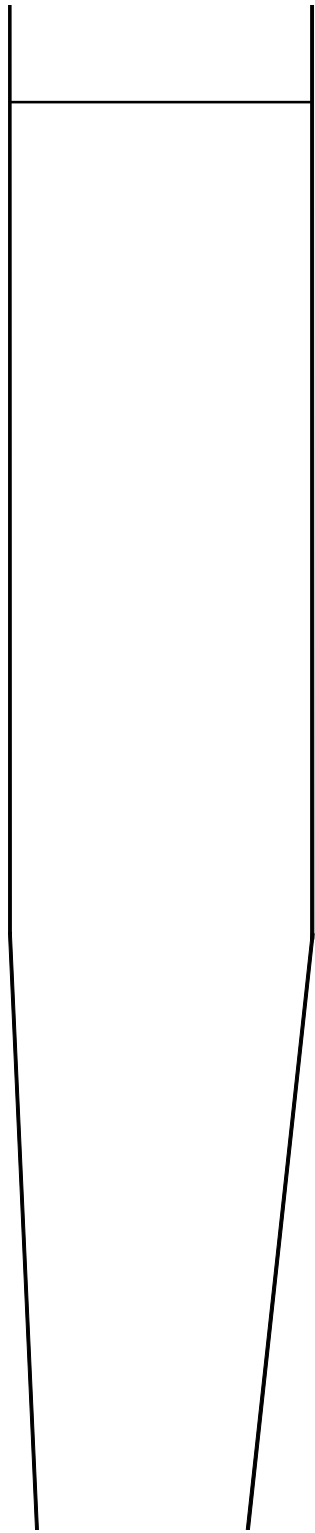
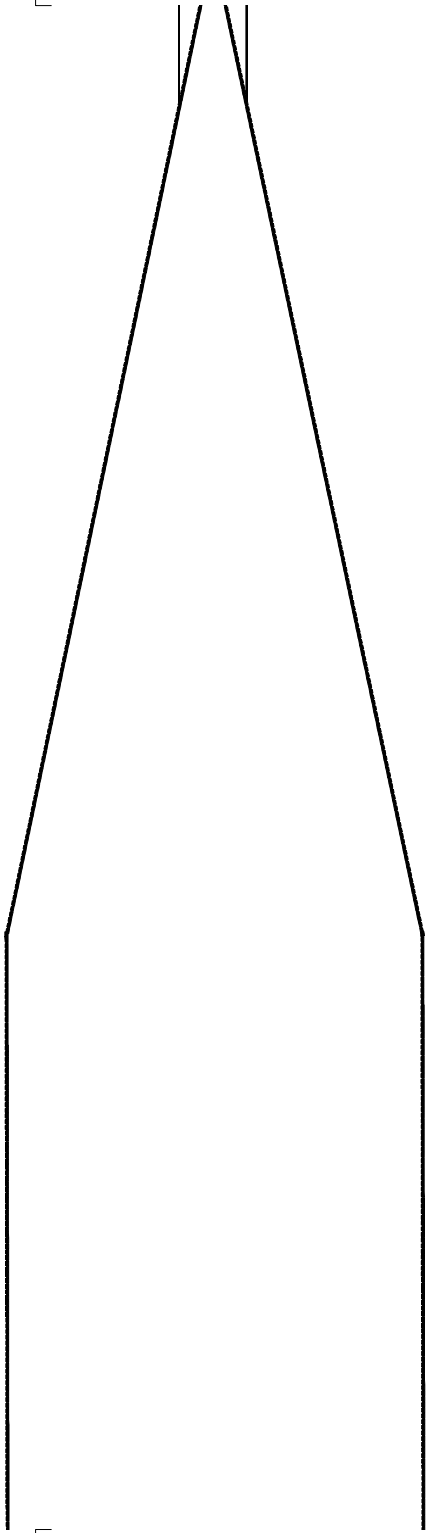

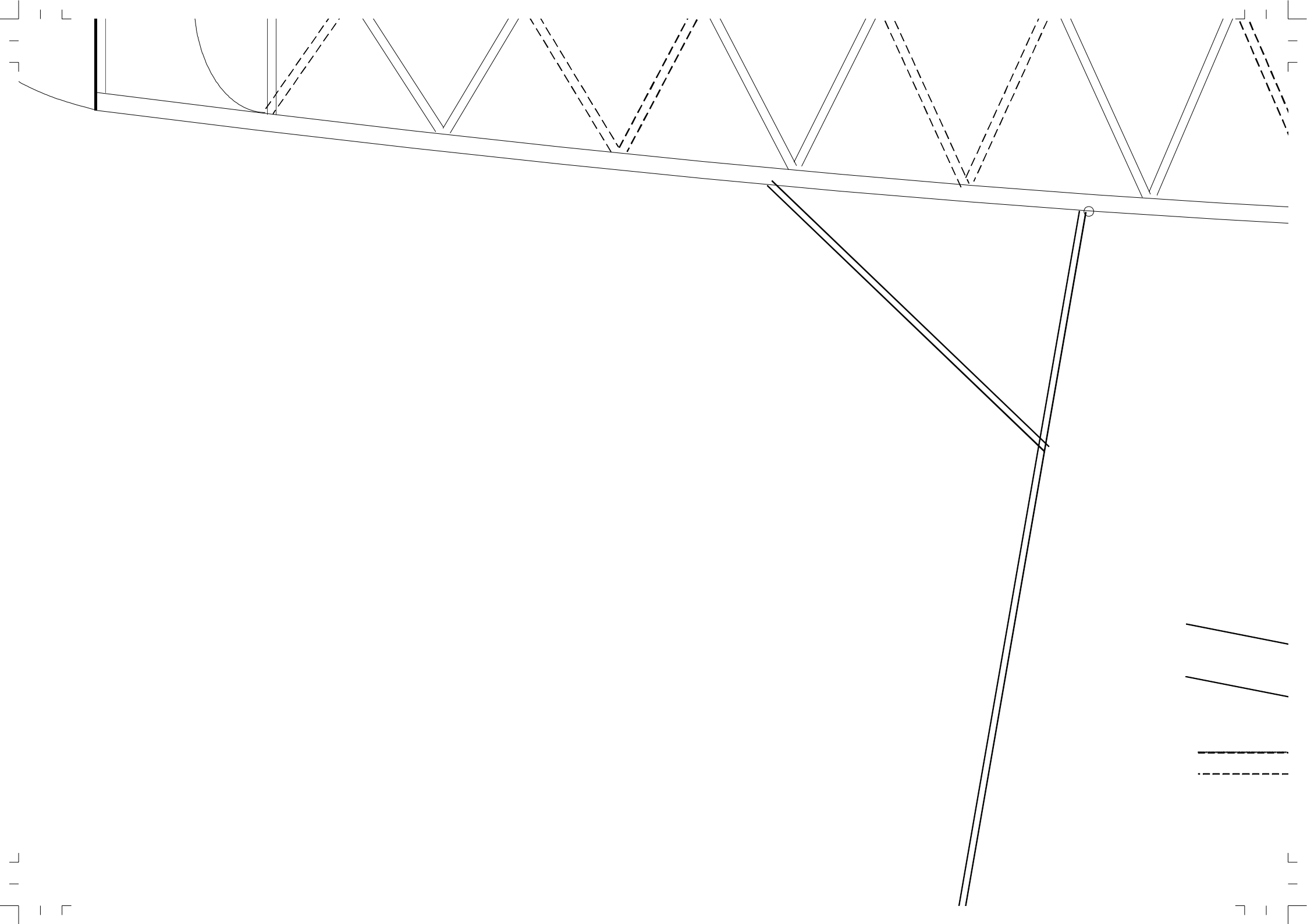

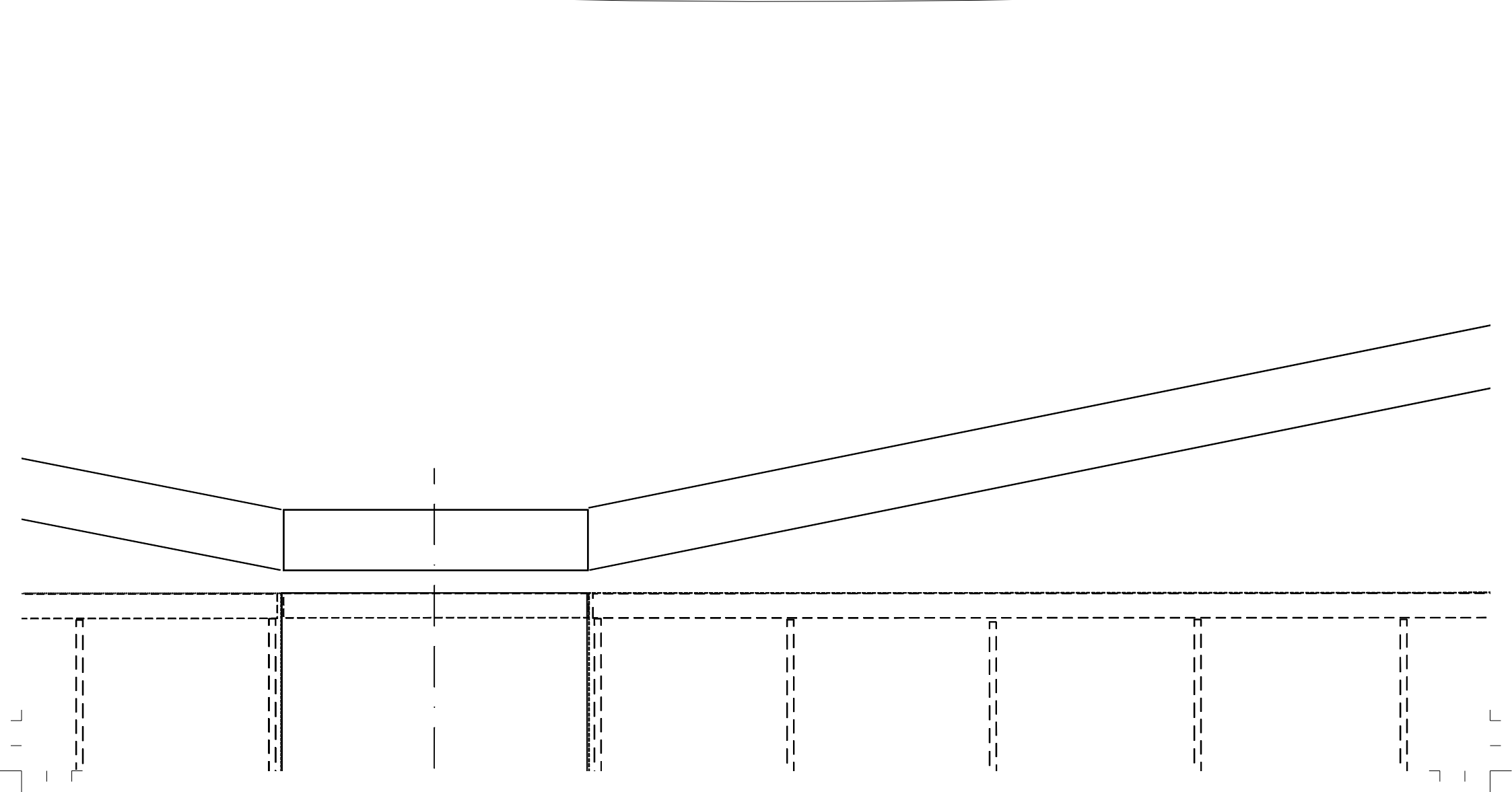
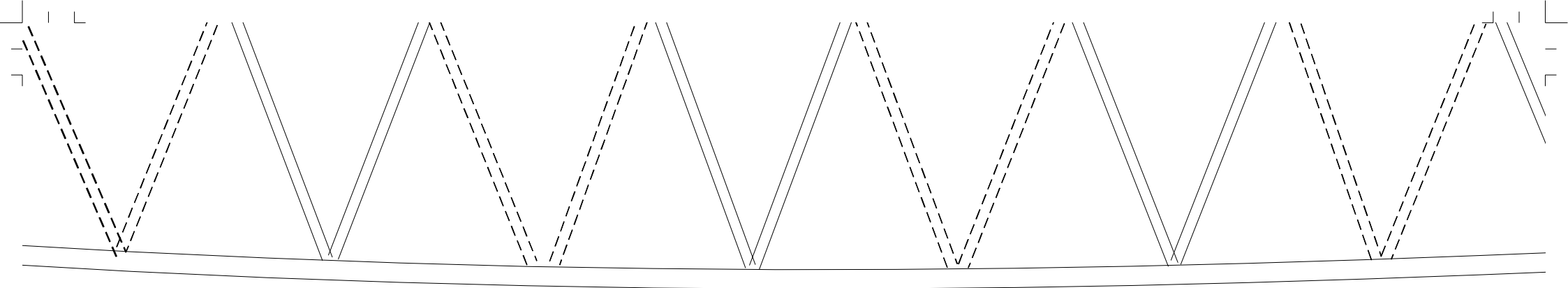

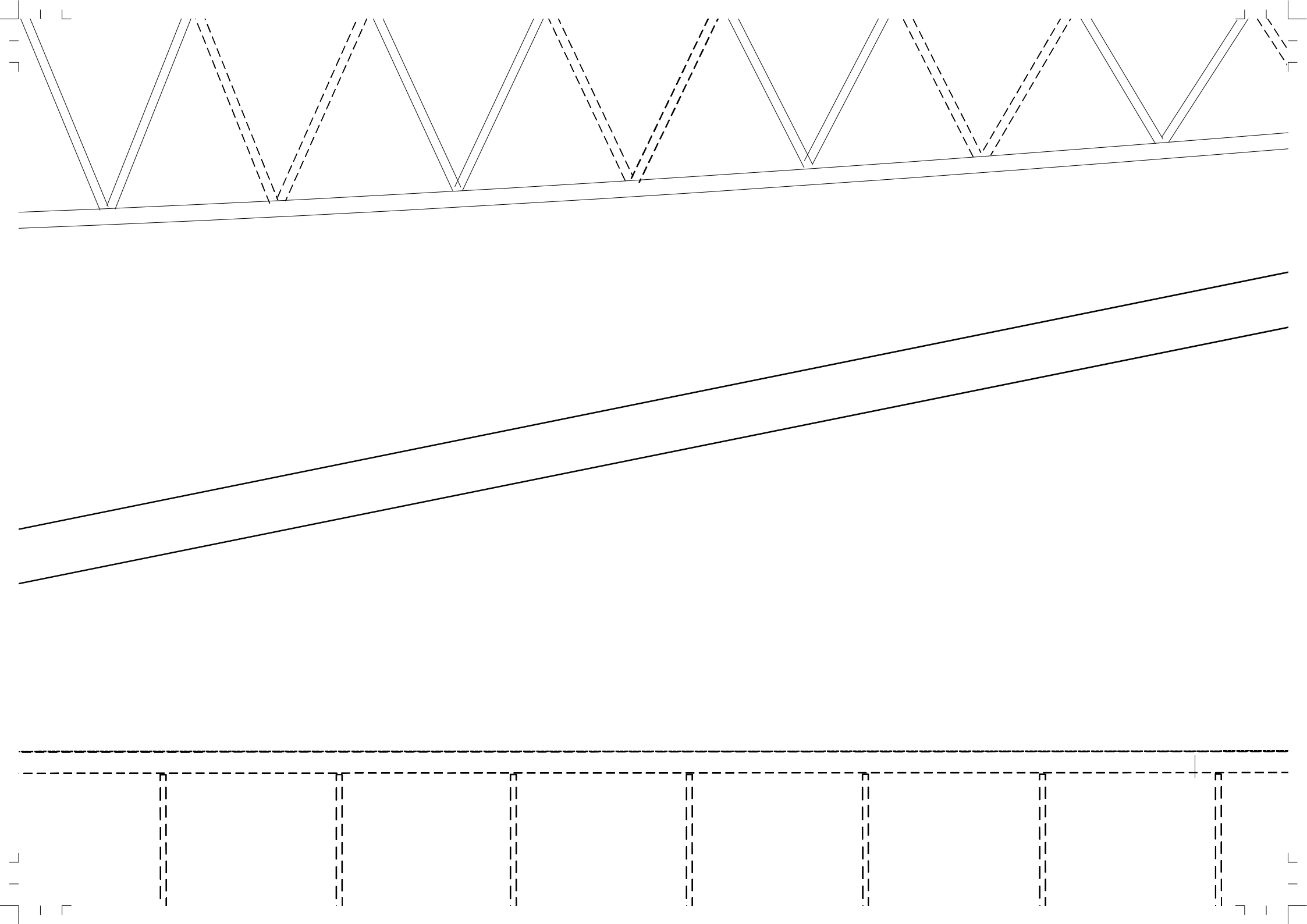

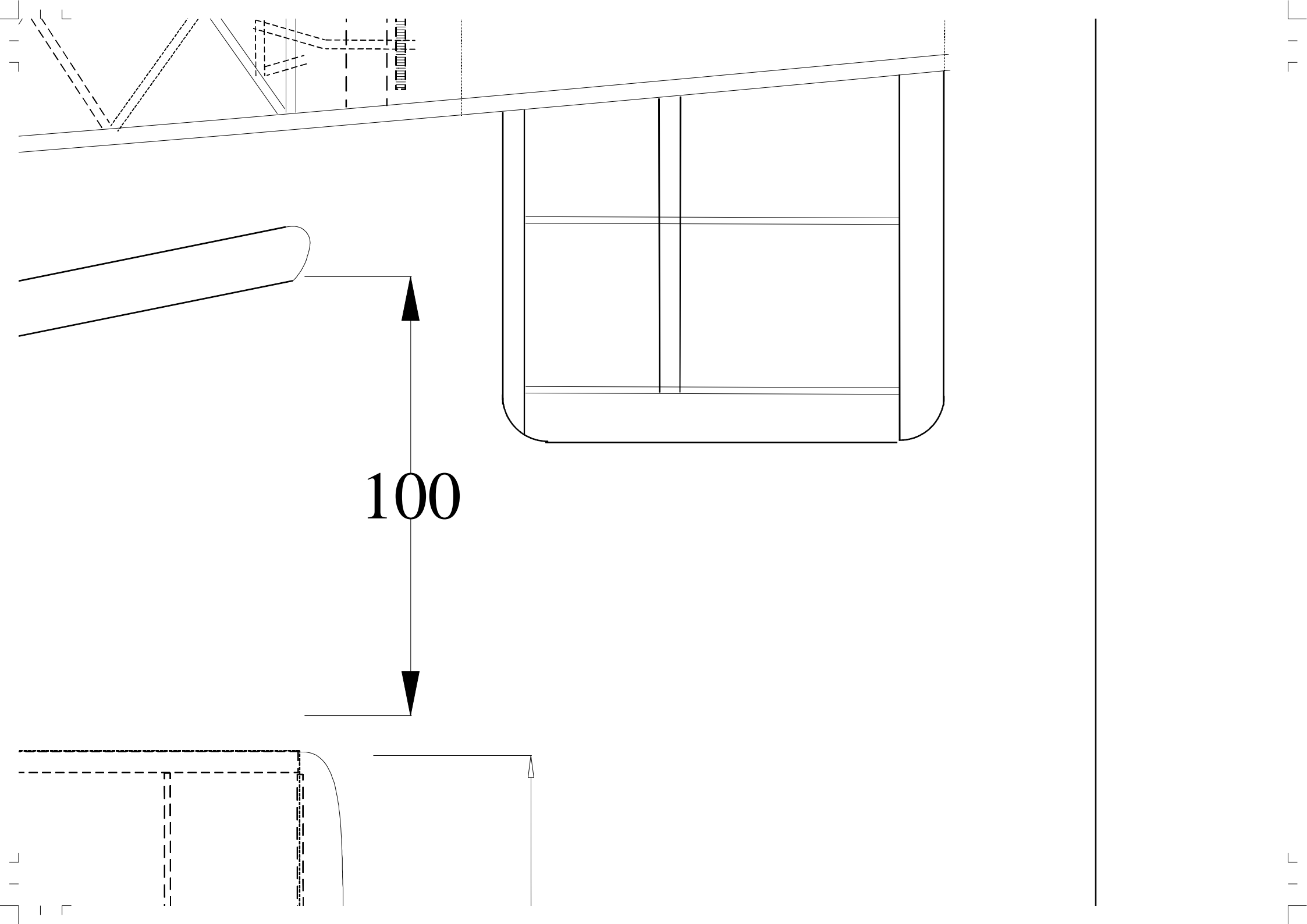

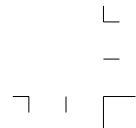
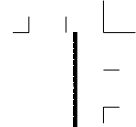

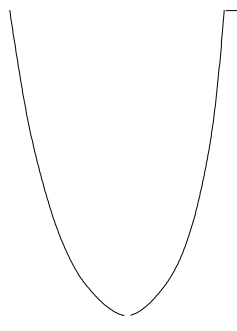
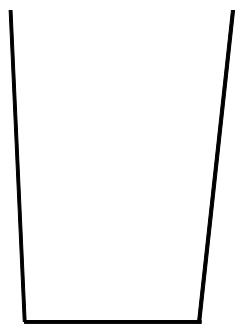
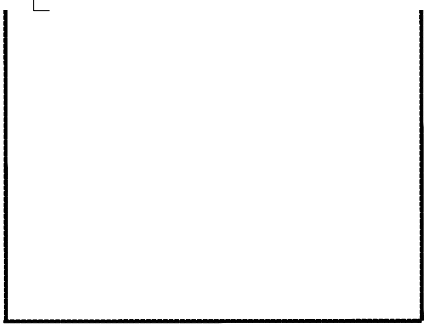

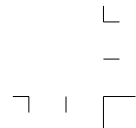
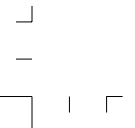
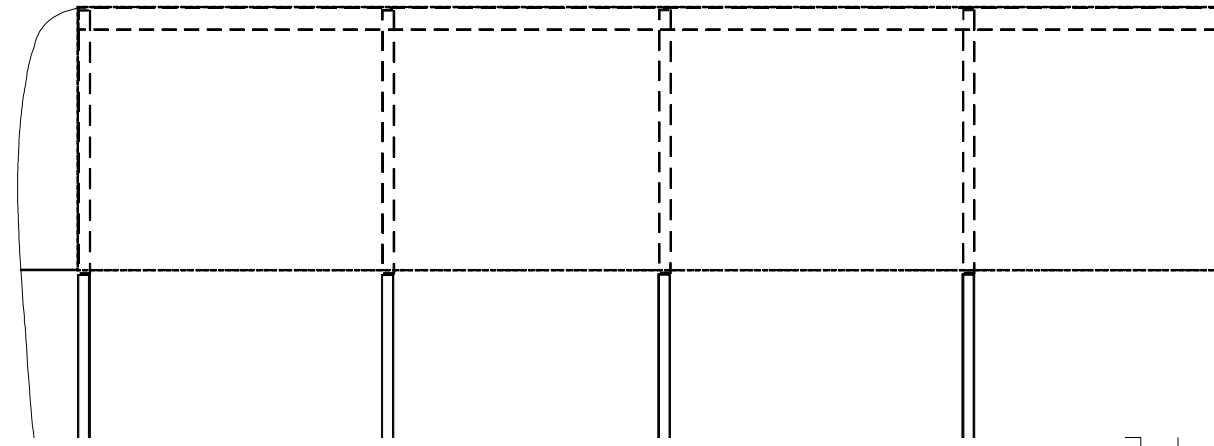
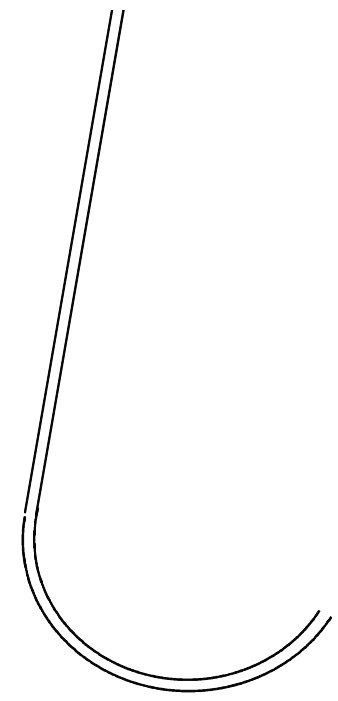
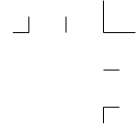
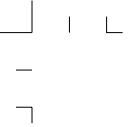

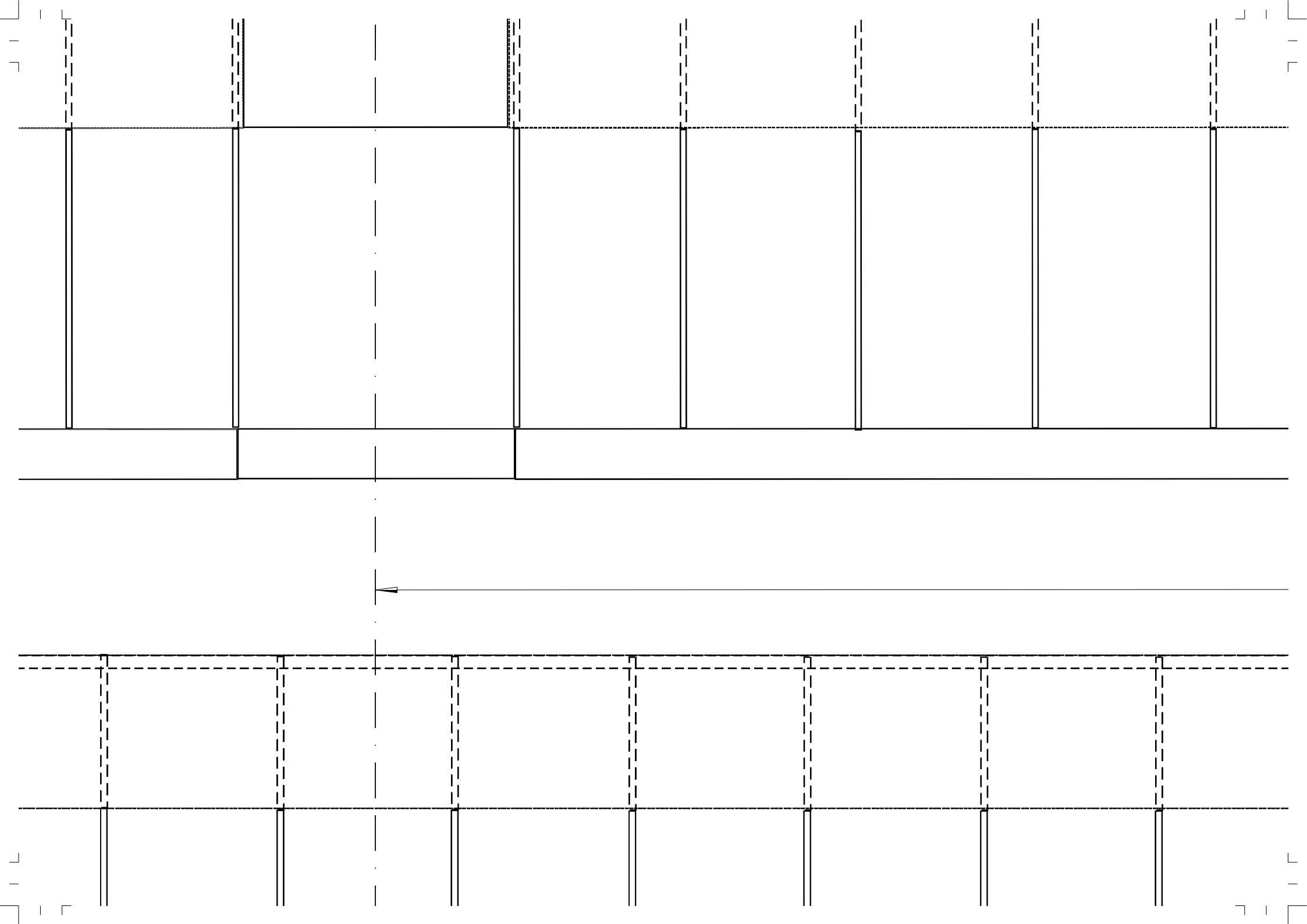

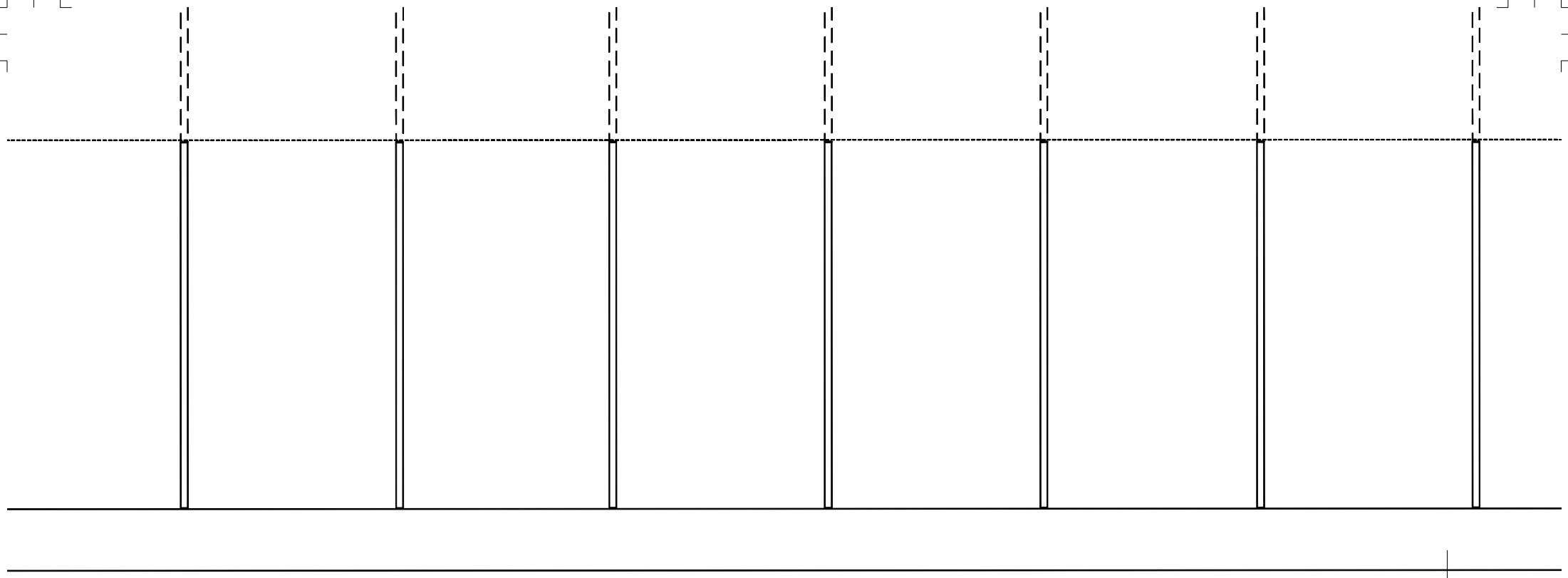

550

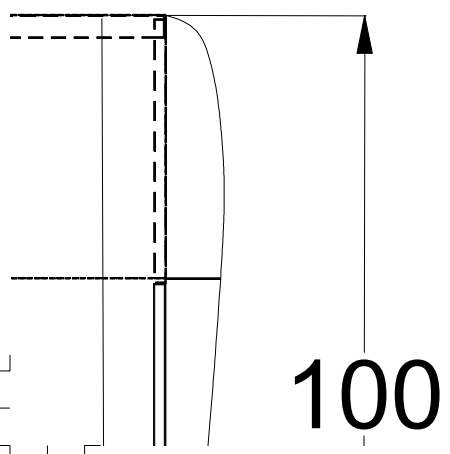

100

KEW-53
Wakefield m

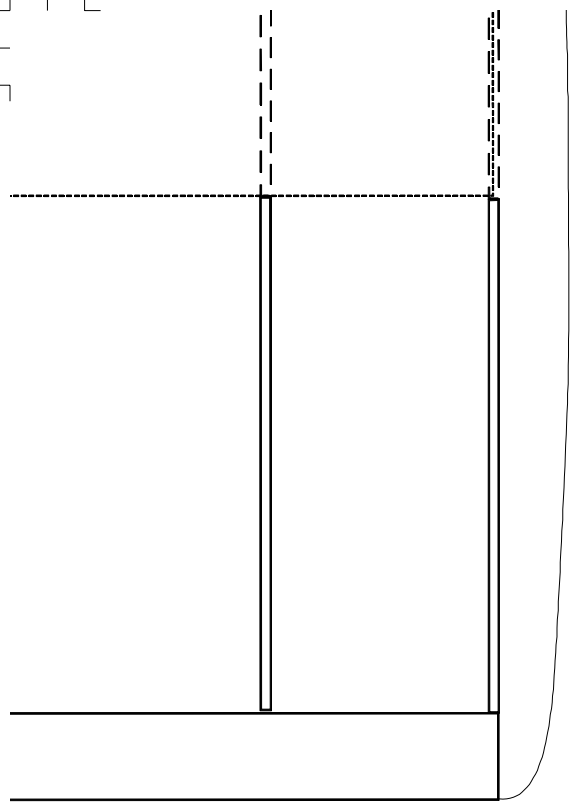

130

model konstrueret af

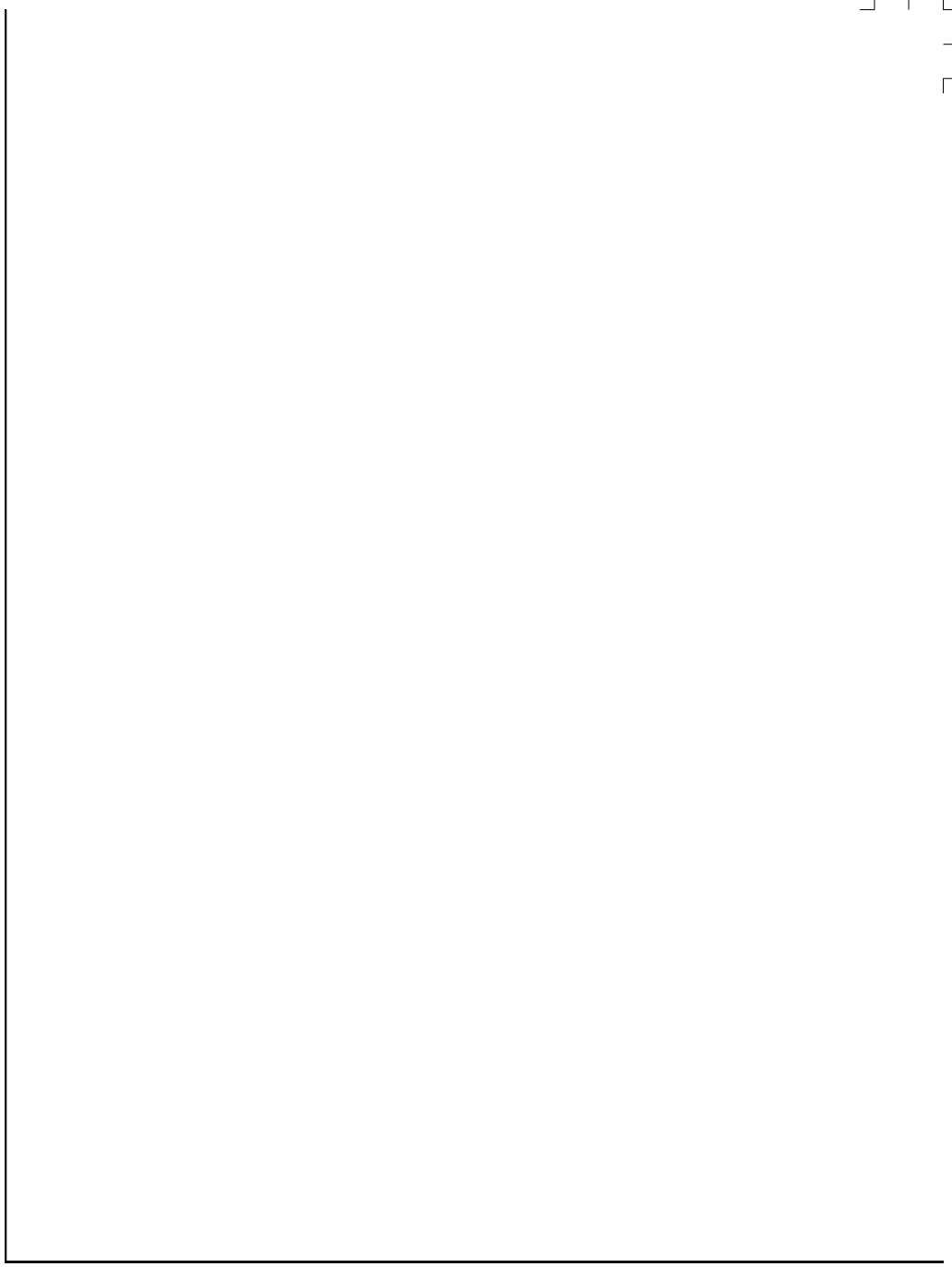

/



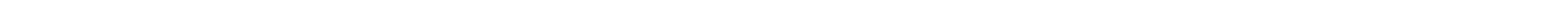

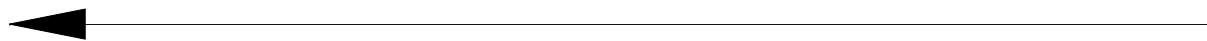
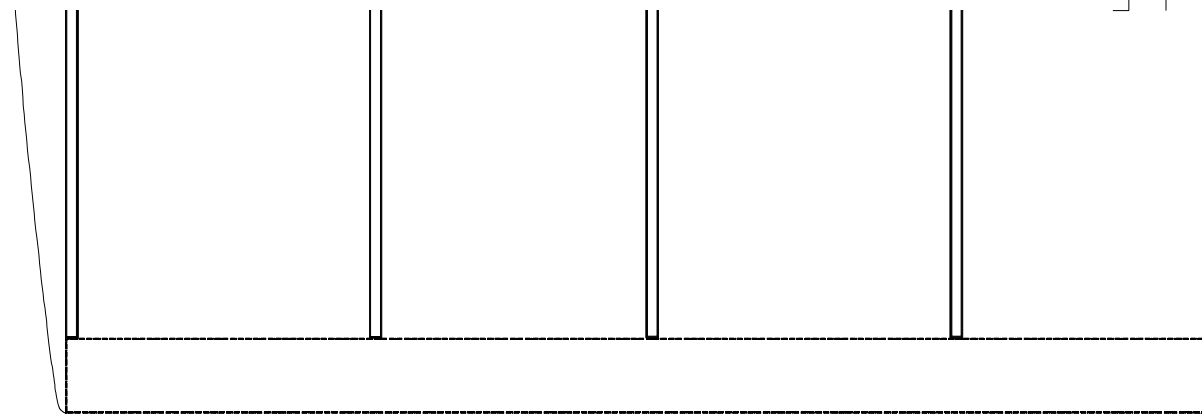

455

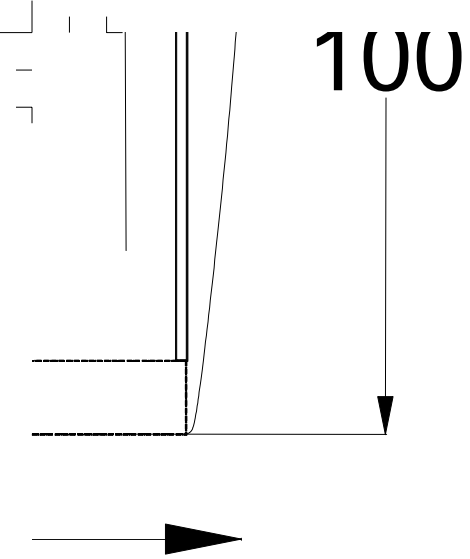

Wakefield m
Karl Erik Wid

Areal, vinge:

Areal, haleplade:

Areal, i alt:

Vægt:

Propeller: 48

Gummi: 2x10

Genteg

model konstrueret af
idell, Danmark, 1953

: 14.9 dm²

plan: 3.6 dm²

18.5 dm²

235 g

48 cm diameter, 60 cm stigning, frihjul

100 g, 14 strenge 6x1 mm Dunlop

egnet fra original blyantsskitse 2013 KEW